

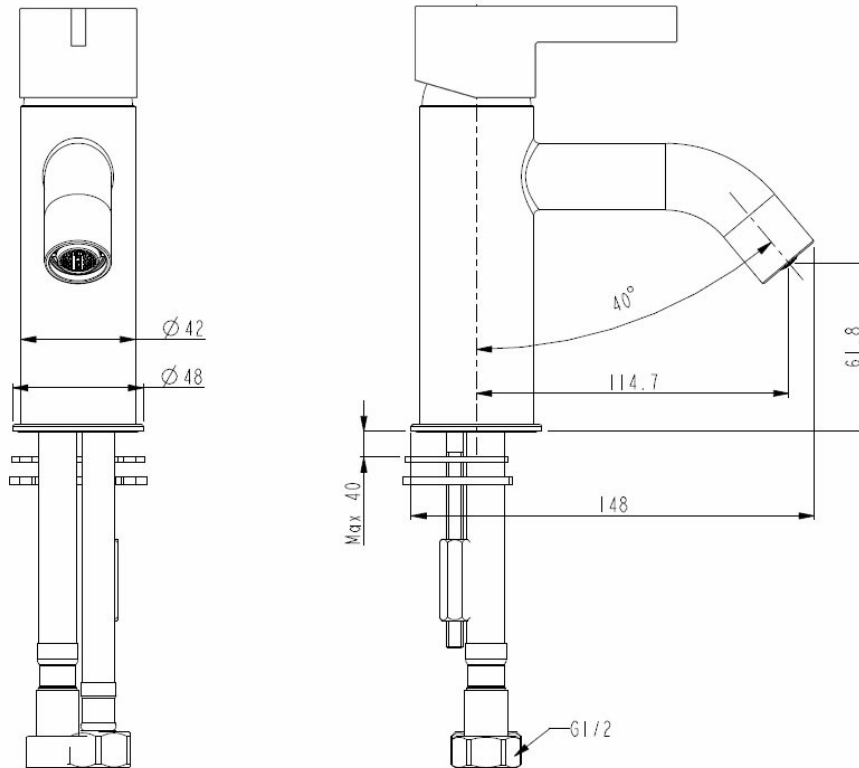









TELAIO BASIN MIXER - CHROME















41951.02
\$859

ELEMENTI
BATHWARE



| | | |
|--|-------------------------------------|--|
|  | Check Stop | Ball valves with integrated check stop. |
|  | Intelligent Valve Technology | Superior quality valves designed in New Zealand specifically to suit New Zealand conditions. |
| 5 | Guarantee | 5 Year Guarantee on Coloured Finishes |
| 10 | Guarantee | 10 Year Guarantee |
|  | 5 Star WELS rating | Mains Pressure: 5L/min |
|  | 6 Star WELS rating | Low/Unequal Pressure: 4.5L/min |
|  | Mains Pressure | Suitable for Mains Pressure. |
|  | Multi Pressure | Suitable for Multi Pressure. |
|  | Lead Free | Fully compliant to the new Lead Free/DZR MBIE Acceptable Solution G12/AS1. |
|  | Flawless Finish | Advanced plating provides a durable surface with a long lasting finish |
|  | Effortless Control | Advanced cartridge technology provides a wide operating angle and smooth operation |



| | | |
|--|---|---|
|  | Base Ring | Includes base ring. |
|  | Indicators | Includes standard and coloured indicators. |
|  | 5 Ticks Standards Mark | The 5 Ticks Standards Mark™ certifies this product meet strict quality, safety, and performance standards. |
|  | Chrome Plate | A base of copper is first applied followed by a layer of nickel and then finally a hard gloss coating of chromium to achieve a shiny hard wearing finish. |
|  | Electroplated: Gun Metal | Electrical current is used to dissolve components into Lacquer that then adhere to the surface. |
|  | Electroplated: Black | Electrical current is used to dissolve components into Lacquer that then adhere to the surface. |
|  | Electroplated with PVD: Brushed Nickel | Electrical current is used to dissolve components into Lacquer that then adhere to the surface. A thin metal-spray coating in the form of very thin layers is finally applied using PVD process. |
|  | Electroplated with PVD: Brushed Brass | Electrical current is used to dissolve components into Lacquer that then adhere to the surface. A thin metal-spray coating in the form of very thin layers is finally applied using PVD process. |
|  | BPIR - Importer | Robertson NZ Ltd. |
|  | BPIR - Place of Manufacture | China |
|  | BPIR - Relevance Documentation | For detailed information on Relevant Building Codes & Statement of Contribution please visit ROBERTSON.CO.NZ/DOWNLOADS and browse the relevant section |
|  | BPIR - Scope of use | 1 Tap hole basin mixers are used to control water flow and temperature in basins designed with a single tap hole, offering a clean and simple installation. |
|  | BPIR - B2.3.1 Durability | This product complies with Building Code Regulation B2.3.1 Durability |
|  | BPIR - G12.3.2 (A) G12 Water Supplies | This product complies with Building Code Regulation G12.3.2 (A) G12 Water Supplies |
|  | BPIR - G12.3.7 G12 Water Supplies | This product complies with Building Code Regulation G12.3.7 G12 Water Supplies |

Sophisticated and contemporary in design, Telaio will elevate your bathroom. This collection takes inspiration from timeless simplicity and clean lines. By combining this classic influence with modern elements, Telaio achieves harmony between tradition and style.